



Bag

Finished size: 9" x 1-1/2" x 8-1/2" (23 x 4 x 20 cm)

You need

- PFAFF® creative™ Sewing and Embroidery Machine
- 12" x 55" (30 cm x 140 cm) Black denim fabric
- 15" x 55" (38 x 140 cm) Green silk fabric
- 55" (140 cm) Black ribbon 5/8" (15 mm) wide
- 12" x 55" (30 x 140 cm) Fusible batting
- Tear Away stabilizer
- Green cotton yarn
- Sewing thread to match green cotton yarn
- Sewing thread to match the green silk fabric
- Sewing thread to match black ribbon
- Black Sulky Rayon Embroidery thread 30wt
- Chalk marker

PFAFF® Accessories

- Narrow Edge Foot (820609-096)
- creative™ Yarn Couching Foot Set (820 912-096)
- Sewing Stars Foot with IDT™ (820 654-096)

3/8" (1 cm) seam allowance included in all measurements.

Cut

- From denim fabric: 1 front piece 11" x 13-3/4" (28 x 35 cm)
2 strips for handles 2 3/4" x 16" (7 x 41 cm)
- From green fabric: 1 front piece 10 5/8" x 11" (27 x 28 cm)
1 back piece 10-5/8" x 11" (27 x 28 cm)
2 lining pieces 10 5/8" x 11" (27 x 28 cm)
1 strip for binding 3.5" x 21" (9 x 53 cm)
- From fusible batting: 2 pieces 10 5/8" x 11" (27 x 28 cm)
- From Black ribbon: 2 pieces 16" (41 cm) for handles
2 pieces 11" (28 cm) for front bag
1 piece 1" (2.5 cm) for small embellished rectangle

Embellish

- Using chalk marker draw two rectangles on the black denim fabric:
- 1 – 6" x 10" (15 x 25 cm) large rectangle in the lower half of black fabric as shown in Illustration.
- 1 – 2-3/8" x 2-3/4" (6 x 7 cm) small rectangle in the upper half of black fabric as shown in Illustration.

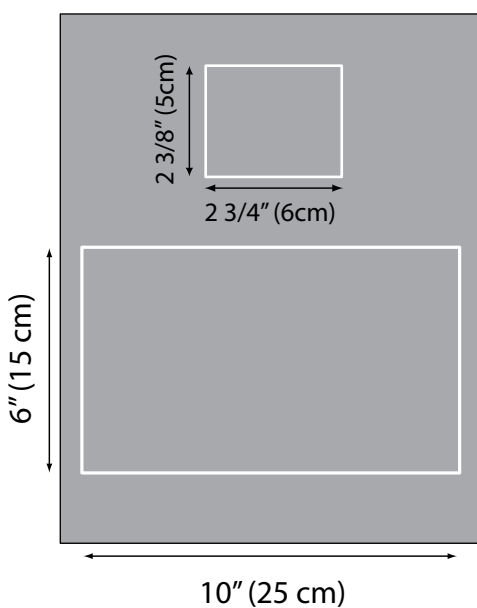

Snap on the creative™ Yarn Couching Foot and set your PFAFF® Sewing Machine for Sensormatic Free Motion sewing. Thread the top and bobbin with sewing thread to match green yarn. Thread the green yarn through the Yarn Couching Foot following manufacturers' instructions. Place stabilizer behind black fabric.

On the 6" x 10" (15 x 25 cm) rectangle use free motion to fill the rectangle with stone shapes. Sew each stone shape twice to create a thicker look.

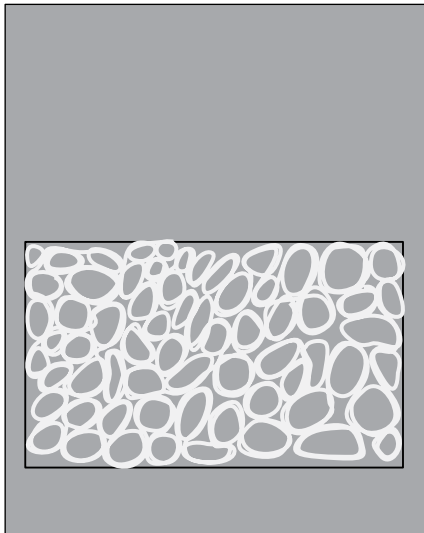

On the 2-3/8" x 2-3/4" (6 x 7 cm) rectangle start free motion just inside the chalk line and echo stitch with the green yarn following the rectangle from the outside to the center.

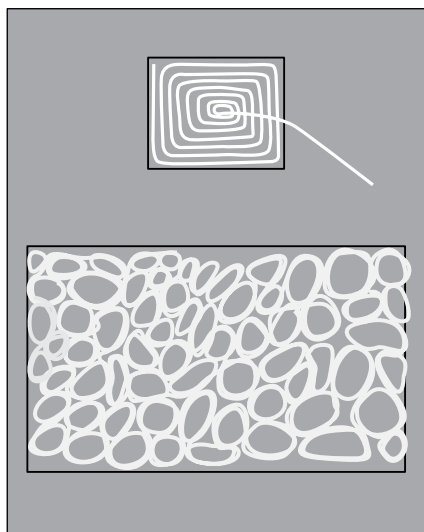

Cut out large embellished rectangle slightly larger to 6" x 10-3/8" (15 x 26.5 cm)
Cut out small embellished rectangle to 3-1/2" x 3" (9 x 7.5 cm). Check that embellished
yarn is centered in small rectangle.

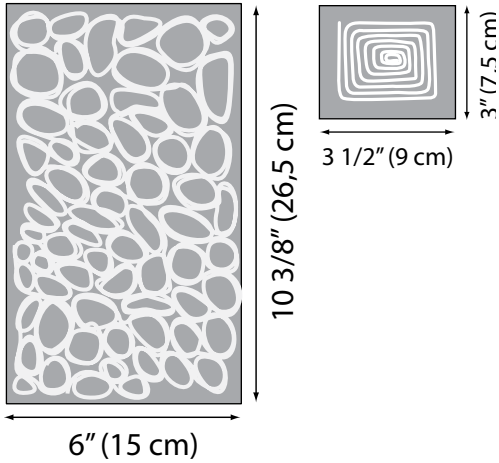

Sew

Press the fusible batting to the wrong side of the green silk front and back pieces. Center the black fabric with yarn embellished stone shapes to the right side of green front piece. Pin and baste in place. Center the black ribbon over the long side edges on the black fabric and pin in place.

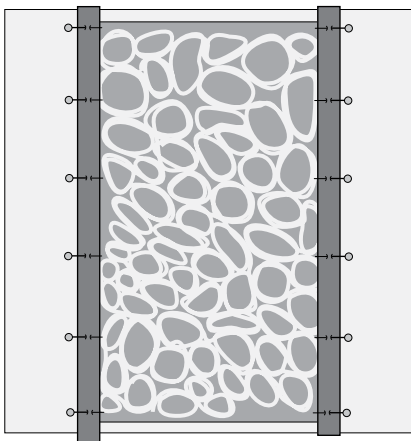

Snap on the Narrow Edge Foot. Select straight stitch. Thread with sewing thread to match ribbon in the bobbin and Sulky Black 30wt rayon embroidery thread on top. Sew the ribbon in place.

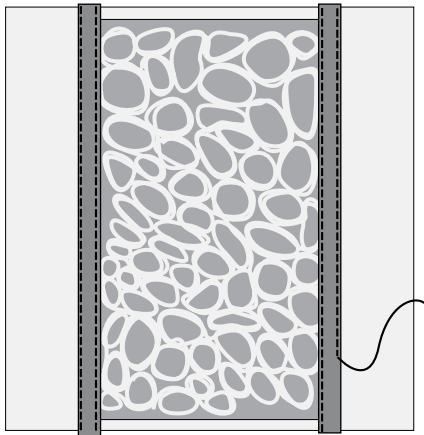

Snap on the Sewing Stars Foot. Select a zig zag and adjust the length and width for a satin stitch. Cut 1" (2.5 cm) piece of ribbon, fold in half wrong sides together and centre behind lower section of small decorated rectangle. Edgestitch in place to secure. Pin the decorated rectangle 1-1/4" (3 cm) down from top and centred on the back bag and sew in place with the satin stitch.

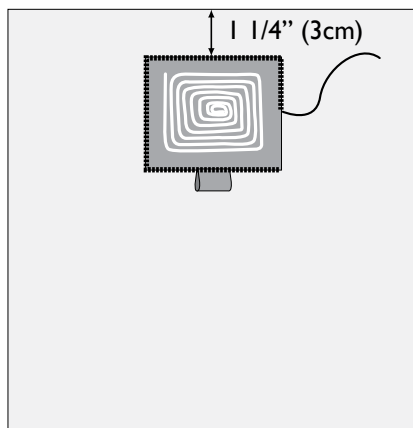

Snap on Presser Foot 0. Thread your PFAFF® sewing machine with sewing thread to match the green silk fabric top and bobbin. Place the front and back pieces right sides together. Sew the bottom and side seams.

To make a 1.5" (4 cm) wide base and side for the bag, match the side seam to bottom seam and sew across the corner 7/8" (2 cm) from the tip as illustrated. Repeat for opposite side.

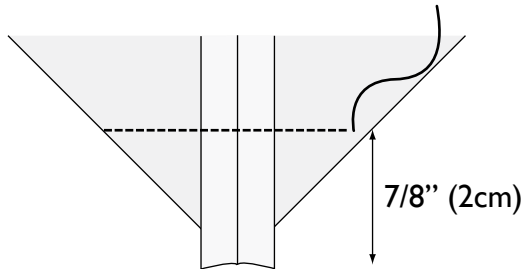

Attach Narrow Edge foot and move needle position slightly to the left. Measure 3/4" (2 cm) out from both sides of side seam and mark. Fold bag along marking, pin and edge stitch from bag bottom corner to top edge.

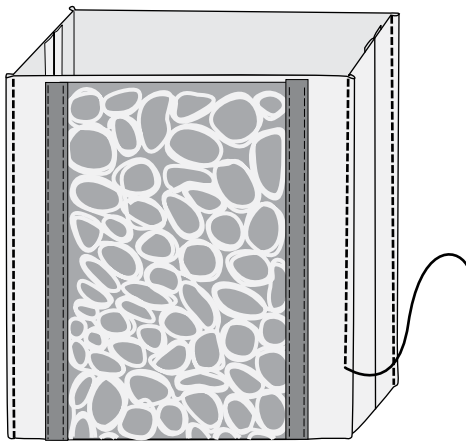

Pin the pieces for the lining, right sides together. Sew side and bottom seams. Create base and sides in the same way as you did with the outer bag. Place the lining inside the bag wrong sides together and pin in place.

Fold the handle strips in half right sides together. Sew the long sides together with a straight stitch. Trim the seam allowance. Turn right side out and press.

Place the black ribbon in the centre of the denim handles and pin in place. Snap on the Narrow Edge Foot. Select Straight stitch. Thread machine with sewing thread to match ribbon in bobbin and Sulky 30wt Black rayon thread on top. Sew the ribbon in place.

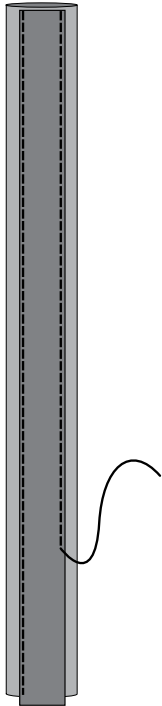

Pin the handles to the inside of the bag (wrong sides together) 2" (5 cm) from the side seams.

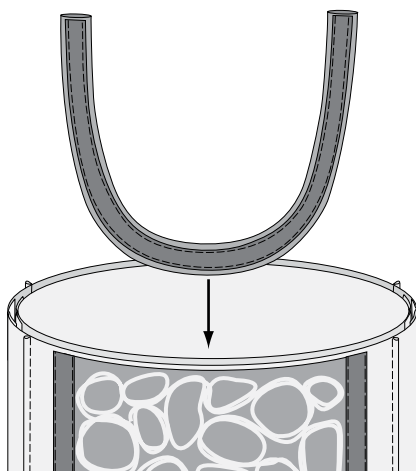

Snap on Presser Foot 0. Sew the opening and handles in place with a straight stitch.

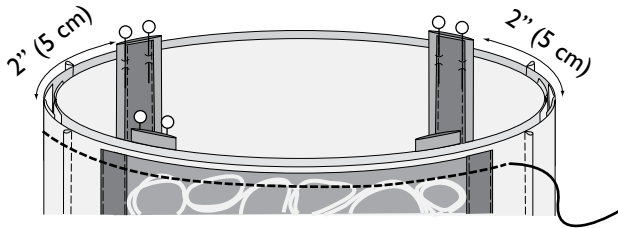

Fold the green binding strip in half lengthwise with, wrong side together. Press. Pin the binding to the bag opening, right sides together. Continue pinning around the top until the short ends of binding meet. Sew the short edges together, trim the seam allowance and finger press seam open. Sew the binding in place.

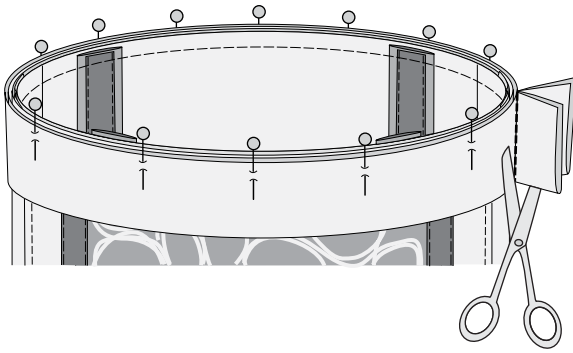

Fold the binding to the inside of the bag and pin in place. Snap on the Narrow Edge Foot. Stitch the binding in place from the right side.

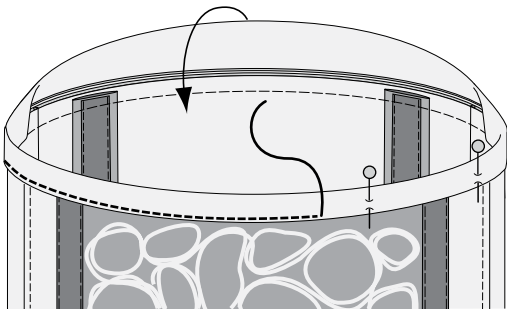

Fold up the handles and straight stitch on the top edge of the bag to hold the handles in the right place.

