

INSTRUCTION MANUAL FOR SEWING MACHINE

1010-1037

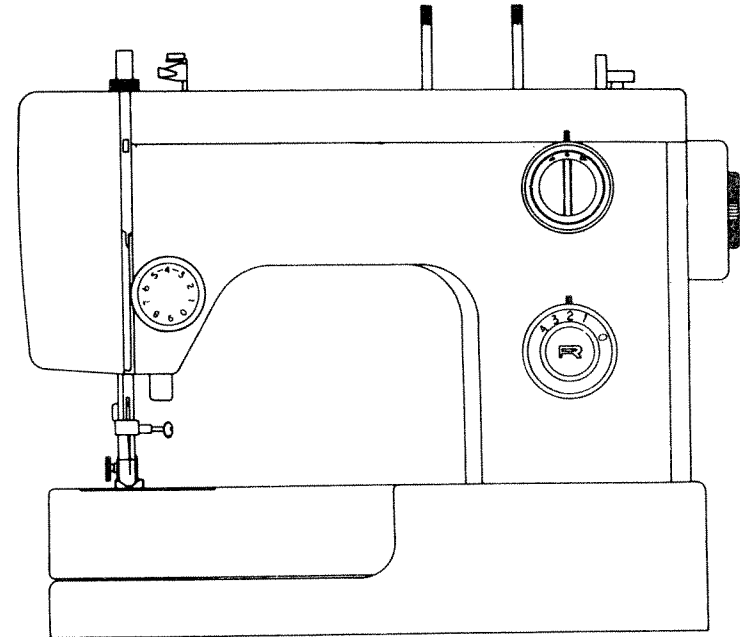

Hobby Model

1010 - 1037

351427004
A
00.12.14

IMPORTANT SAFETY INSTRUCTIONS

When using an electrical appliance, basic safety precautions should always be followed, including the following:

Read all instructions before using (this sewing machine)

DANGER To reduce the risk of electric shock:

An appliance should never be left unattended when plugged in. Always unplug this appliance from the electric outlet immediately after using and before cleaning. Always unplug before relamping, Replace bulb with same type rated 15 watts.

WARNING To reduce the risk of burns, fire, electric shock, or injury to persons:

1. Do not allow to be used as a toy. Close attention is necessary when this appliance is used by or near children.
2. Use this appliance only for its intended use as described in this manual. Use only attachments recommended by the manufacturer as contained in this manual.
3. Never operate this appliance if it has a damaged cord or plug, if it is not working properly, if it has been dropped or damaged, or dropped into water. Return the appliance to the nearest authorized dealer or service center for examination, repair, electrical or mechanical adjustment.
4. Never operate the appliance with any air openings blocked. Keep ventilation openings of the sewing machine and foot controller free from the accumulation of lint, dust, and loose cloth.
5. Never drop or insert any object into any opening.
6. Do not use outdoors.
7. Do not operate where aerosol (spray) products are being used or where oxygen is being administered.
8. To disconnect, turn all controls to the off ("0") position, then remove plug from outlet.
9. Do not unplug by pulling on cord. To unplug, grasp the plug, not the cord.
10. Keep fingers away from all moving parts. Special care is required around the sewing machine needle.
11. Always use the proper needle plate. The wrong plate can cause the needle to break.
12. Do not use bent needles.
13. Do not pull or push fabric while stitching. It may deflect the needle causing it to break.
14. Unplug the sewing machine when making any adjustments in the needle area, such as threading needle, changing needle, threading bobbin, or changing presser foot, etc.
15. Always unplug sewing machine from the electrical outlet when removing covers, lubricating, or when making any other user servicing adjustments mentioned in the instruction manual.

SAVE THESE INSTRUCTIONS

CONTENTS

Names of Parts.....	1 & 2
Accessories.....	3
Before sewing (Power supply and Sewing Lamp).....	4
Take out extension table, free arm sewing.....	5
Winding the bobbin.....	6
Removing bobbin case and bobbin.....	7
Inserting bobbin into bobbin case.....	7
Inserting bobbin case into shuttle race.....	8
Threading upper thread & Twin needle threading.....	9
Drawing up bobbin thread.....	10
Changing sewing directions.....	10
Control dial & Adjusting thread tension.....	11 & 12
Regulating the presser foot pressure.....	13
Drop feed.....	13
Changing needle.....	14
Fabric. Thread. Needle table.....	15
To start sewing.....	16
To finish seam.....	17
Straight stitch.....	18
Zigzag sewing.....	18
Button sewing.....	19
Zipper sewing.....	20
Hemming.....	21
Twin Needle.....	22
Embroidery.....	22
Quilter & Seam guide.....	23
Buttonhole sewing.....	24
Maintenance (Cleaning and oiling).....	25
Checking Performance Problems WHAT TO DO.....	26

NAME OF PARTS (FRONT VIEW)

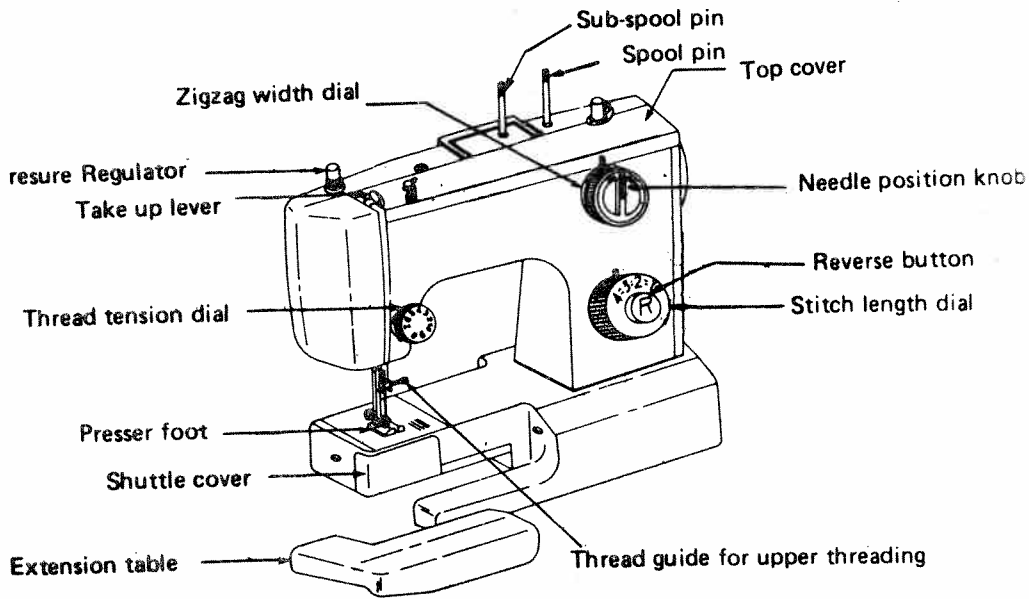

(REAR VIEW)

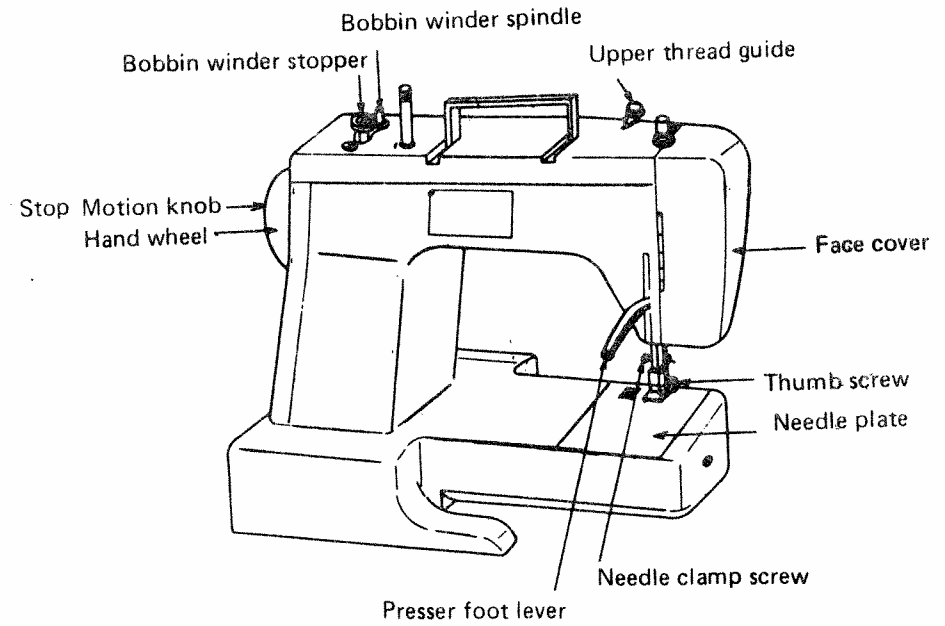

ACCESSORIES

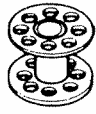

Bobbin



Felt

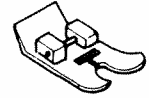

Zigzag foot
(On machine)

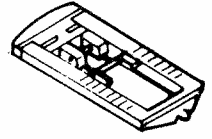

Button hole foot

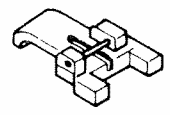

Button foot

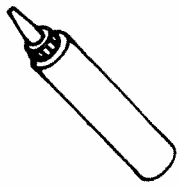

Machine Oil

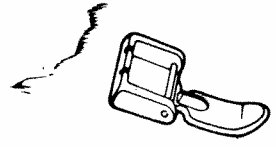

Zipper foot

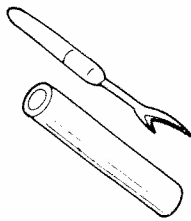

Button hole cutter

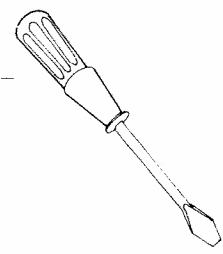

Screw driver

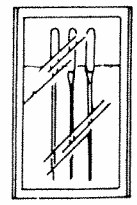

Needle
11 # 14

BEFORE SEWING

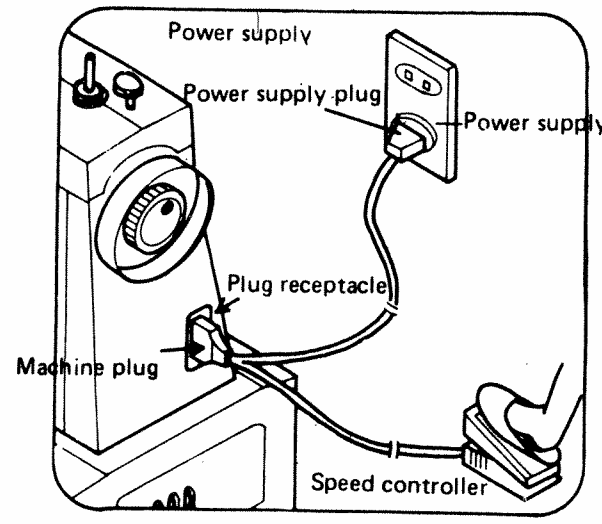

1. Fit plug into the machine.
2. Plug the machine to the power supply.
3. Sewing speed can be varied by the foot control.

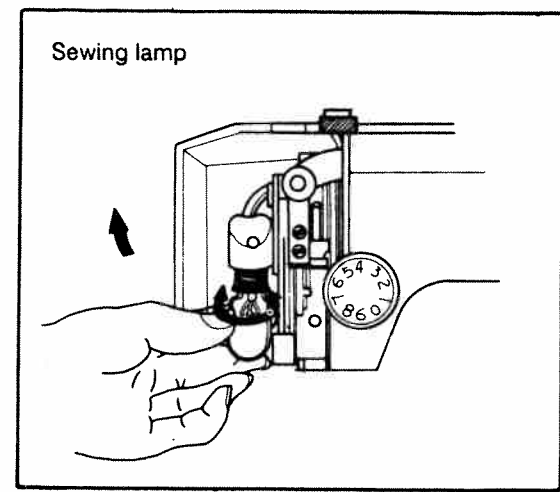

REMOVE OR INSTALL BULB

1. Open face cover in direction of arrow.
2. Remove bulb by unscrewing it counter-clockwise.
3. Install a new bulb by screwing it in clockwise.
4. Use a screw type bulb with 120V / 15W(Max).

IMPORTANT : When leaving the sewing machine unattended, the plug must be removed from the socket outlet.

When servicing the sewing machine, or when removing covers or changing lamps, the machine must be disconnected from the supply by removing the plug from the socket outlet.

REMOVING EXTENSION TABLE

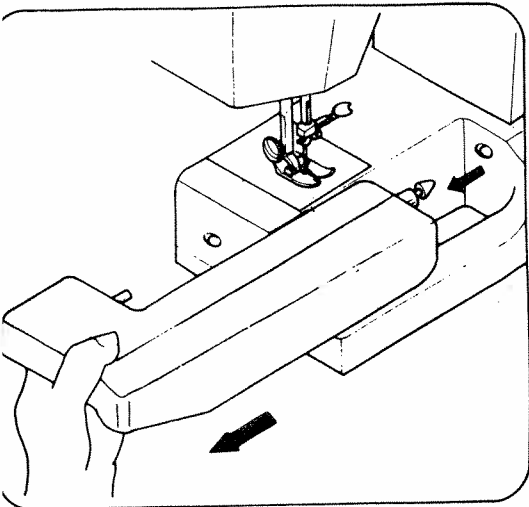

1. Hold the left end of table and pull out in direction of arrow.

FREE-ARM SEWING

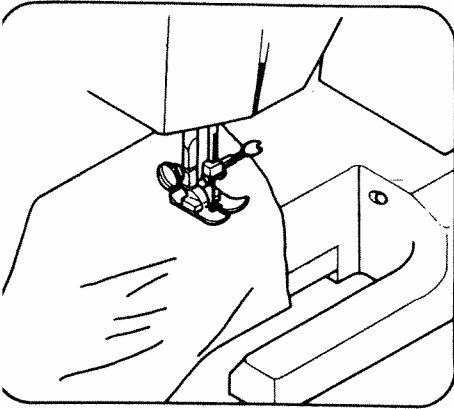

1. This sewing machine can be used as a flat bed machine but easily converts to free arm machine by removing the extension table.
2. Especially useful for sewing sleeves, pant legs, tubular fabrics etc.; more easily.
3. To sew tubular just slip the sleeve or leg of pants on to the free arm as shown at side.

WINDING THE BOBBIN

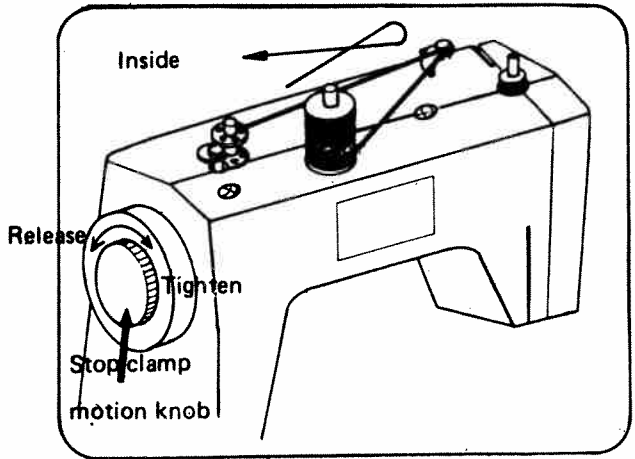

1. Release stop motion knob
2. Thread as shown.
3. When bobbin is filled tighten stop motion knob

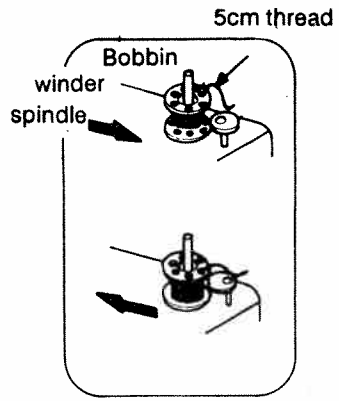

Push bobbin winder spindle in direction of arrow.

When bobbin winding is completed return spindle to original position.

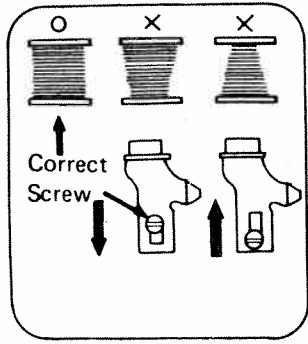

When bobbin winding is incorrect, release the screw of upper thread guide and adjust up or down until bobbin winding is balanced.

REMOVING BOBBIN CASE AND BOBBIN

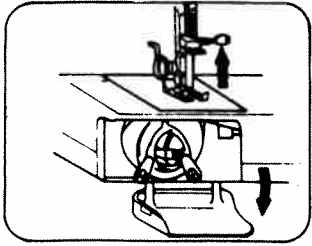

1. Raise needle to its highest position and open the shuttle race cover.

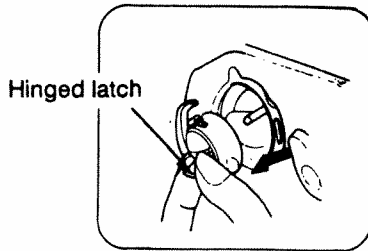

2. Open hinged latch of bobbin case and pull bobbin case out of machine.

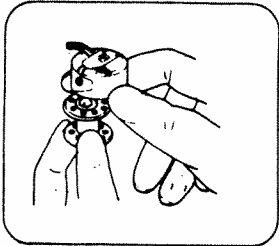

3. Release the latch and bobbin will fall out easily.

INSERTING BOBBIN INTO BOBBIN CASE

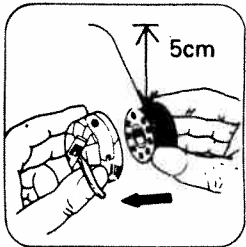

1. Pull off 5cm of thread from bobbin and insert it into bobbin case as shown.

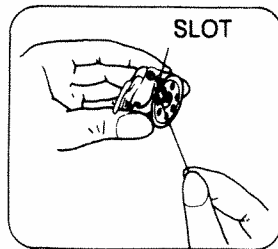

2. Guide the end of thread into slot.

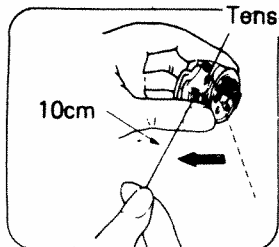

3. Pull into slot and under tension spring and draw out about 10cm of thread.

INSERTING BOBBIN CASE INTO SHUTTLE RACE

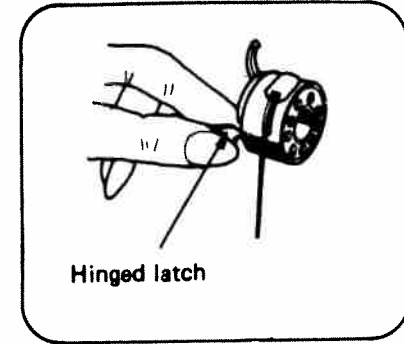

1. Raise needle to its highest position, pulling thread to the front, open the latch of bobbin case and hold it.

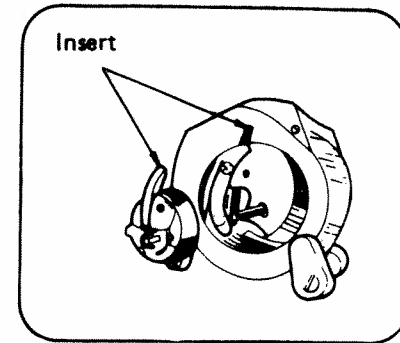

2. Holding latch open, place bobbin case onto centre pin in shuttle and release latch

THREADING UPPER THREAD

Threading the thread from A to I as shown

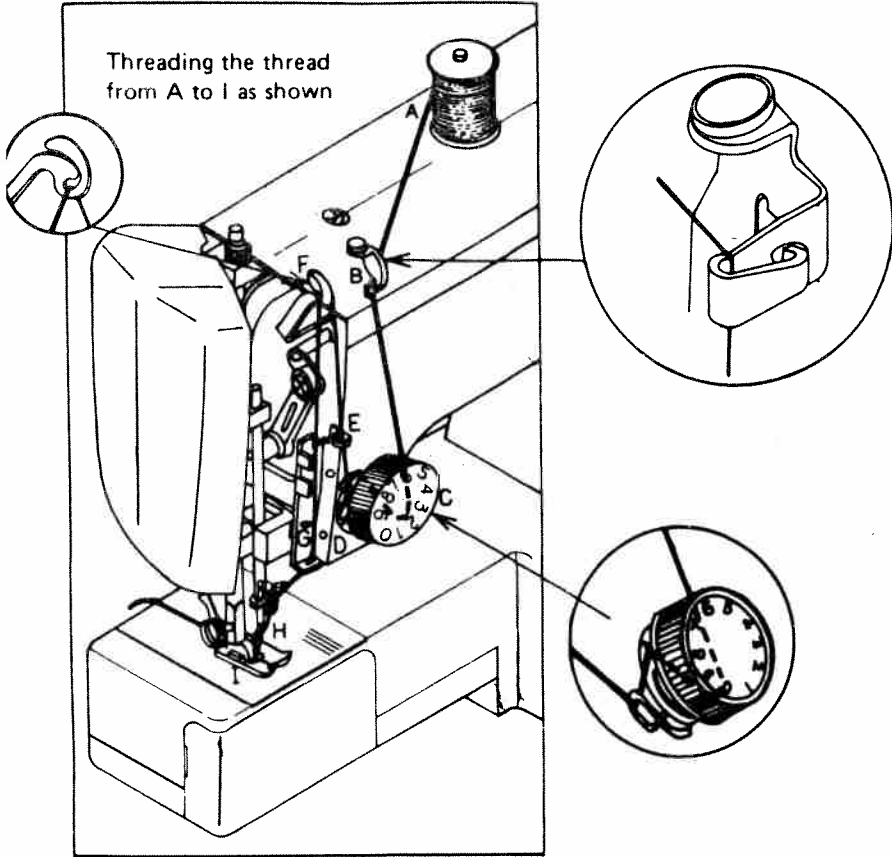

Twin needle threading

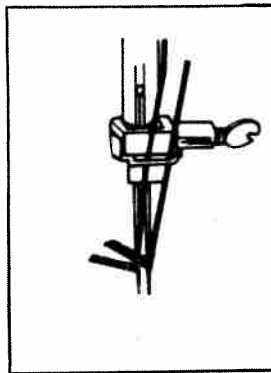
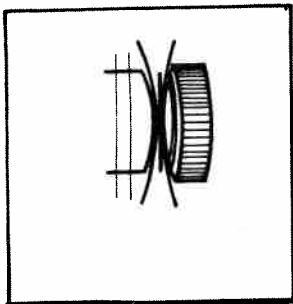

DRAWING UP BOBBIN THREAD

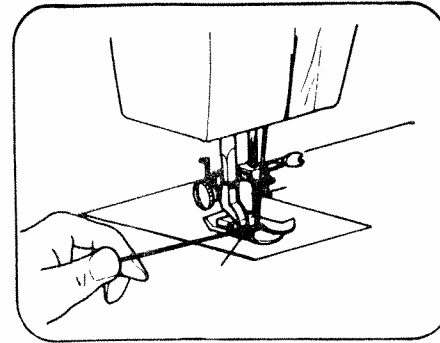

1. Hold upper thread with left hand, turn the hand wheel slowly towards you until the needle goes down and comes up. Then stop the hand wheel when the takeup lever is at its highest position. Lightly draw up the upper thread and the lower thread will be brought up in a loop.

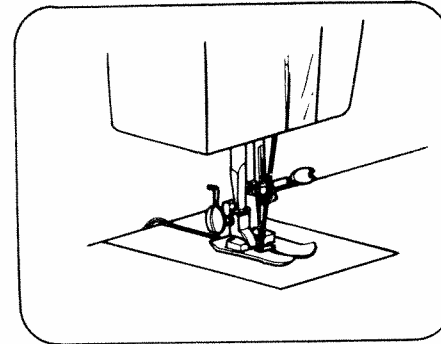

2. Pull out both threads and place them together under presser foot to the rear of machine.

3. Place fabric under presser foot from the front, lower presser foot.

4. Start to sew (see page 16)

CHANGING SEWING DIRECTIONS

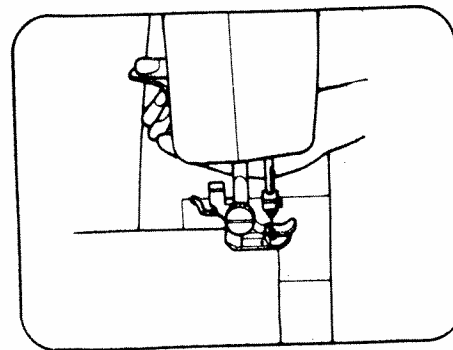

1. Lower needle down into fabric and raise presser foot, pivot the fabric around the needle to change direction as desired.

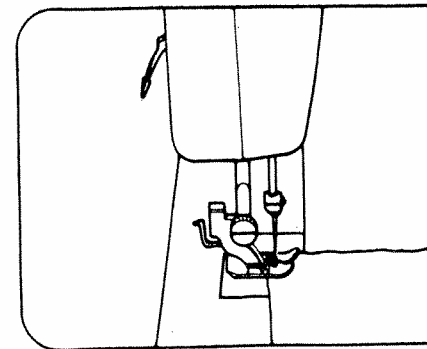

2. Lower presser foot and start to sew.

CONTROL DIAL

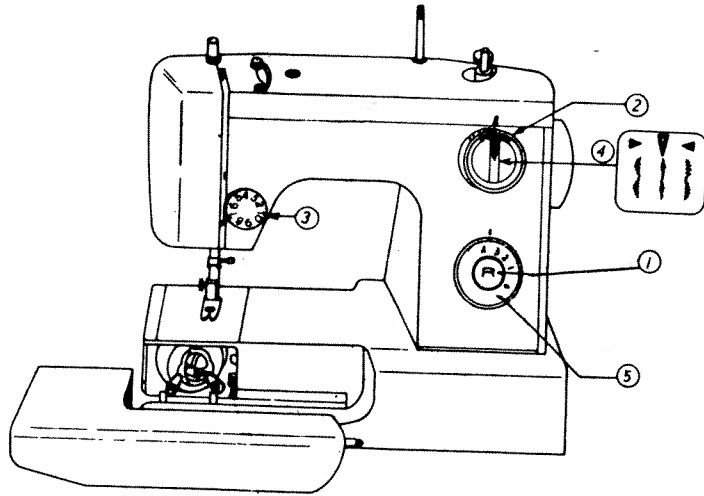

1. Reverse button
2. Zig-zag width dial
3. Thread tension dial
4. Needle position knob
5. Stitch length dial

ADJUSTING THREAD TENSION



Upper thread tension may be adjusted by turning the thread tension dial.

Correct

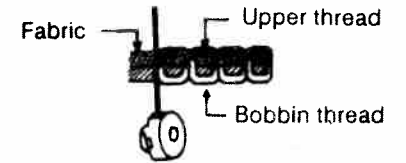

Incorrect

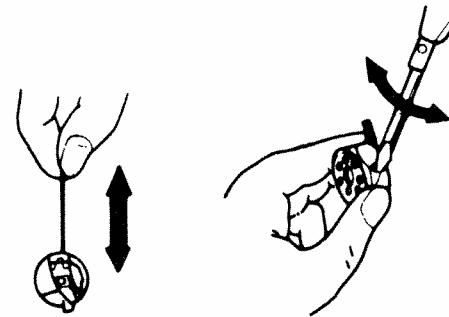
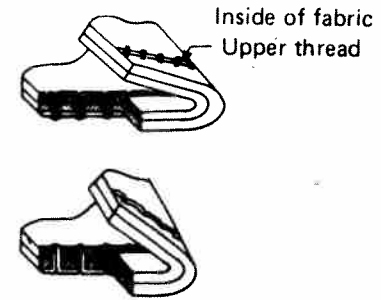

LOWER THREAD TENSION
Lower thread tension can be adjusted by turning screw on bobbin case slightly to the right (clock-wise) to increase tension. Turn the screw (counter-clockwise) to the left to decrease tension.

REGULATING THE PRESSER FOOT PRESSURE

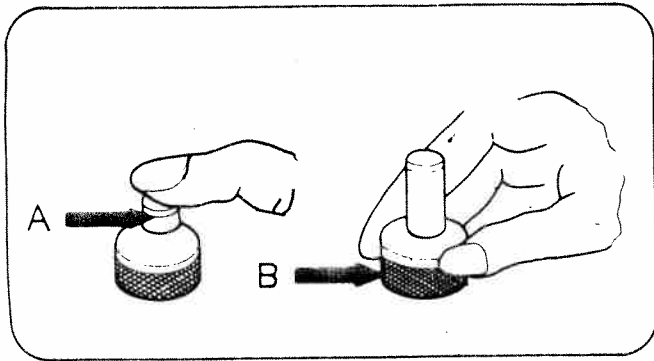

1. Push down inner pin (A) to increase pressure. (Light to medium fabrics)
2. Push down outer ring to release pressure. (Heavy fabrics)
3. Insufficient pressure may cause poor feeding, skipped stitches, or difficulty in guiding the fabric.
4. No pressure adjustment is required when darning or sewing embroidery.

CHANGING NEEDLE

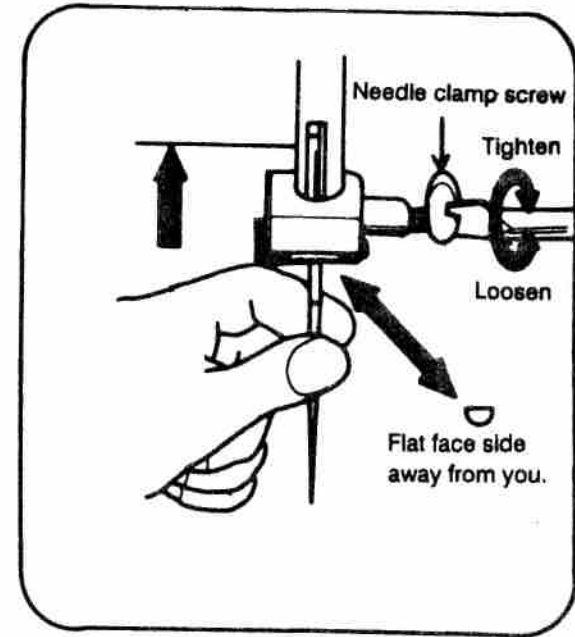

1. Raise needle bar to its highest position.
2. Loosen needle clamp screw and remove old needle.
3. With the flat side of the needle facing away from you, insert needle as far up as it will go.
4. Tighten the needle clamp screw securely.



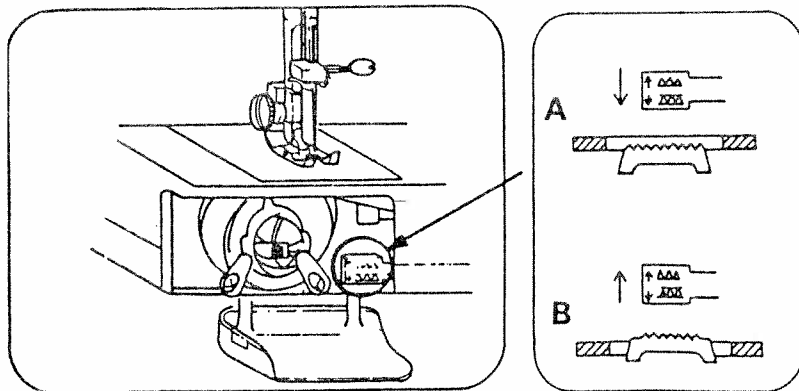











DROP FEED



- A. Push feed lever down to drop feed below needle plate for darning, embroidery, and button sewing.
- B. Push feed lever up to raise feed above needle plate for normal sewing.

FABRIC THREAD NEEDLE TABLE

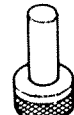
Please note that the following list is a guide when sewing different fabrics.

	Fabric	Thread	Needle	Pressure of presser foot	Length of stitches		Indication of tension
					ST.	ZZ.	
			 HA-1				
Light 	Nylon	80 Cotton	9		1-3	1-4	
	Tricot	60 S. Fiber					
	Silk	50 silk					
	Wool silk	50 S. Fiber Silk	11				
Medium 	Ging ham	60-80 Cotton	11-14		0.5 - 3	0.5 - 4	
	Thin Jersey	60 S. Fiber	11				
	Gabardine	50 Silk					
Heavy 	Denim	50 cotton	14-16		0.5 - 3	0.5 - 4	
	Jersey	50 S. Fiber	11-14				
	Tweed	50 Silk	11-14				

TO START SEWING

Important Hints

1. Raise the take-up lever to its highest position before starting and after stopping sewing.
2. Hold both threads about 10 cms to the rear of machine for the first two or three stitches.
3. Sufficient fabric should be placed under needle before lowering presser foot.
4. Depress foot/Speed control and start to sew.
5. Test the machine stitches on a scrap of fabric you plan to use, adjusting the machine for the length of stitch and tension suitable to your fabric.

Attention

1. When turning the balance wheel manually, always turn it toward you.
2. Guide the cloth gently with your hand.
3. To prevent breaking needle always raise the needle out of the fabric when you stop sewing.

TO FINISH SEAM

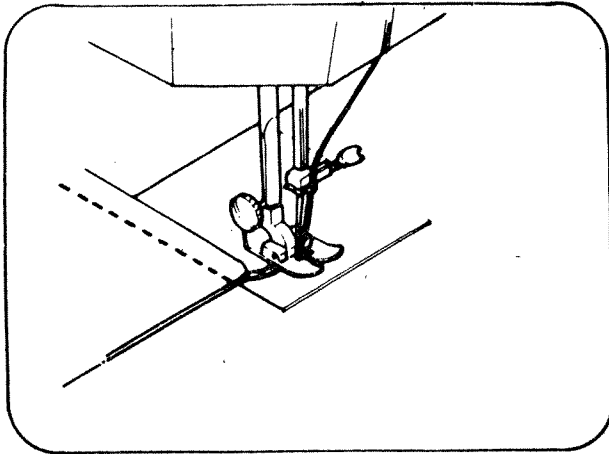

1. Sew to the edge of seam.
2. Push the reverse button and sew in reverse for about 3-4 cms.
3. Raise needle to its highest position.
4. Lift presser foot and pull out the fabric to rear of machine.

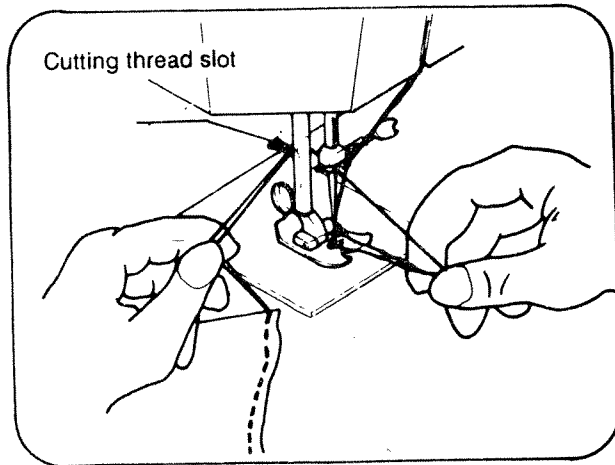

5. Cut threads as shown on the thread cutter.

STRAIGHT STITCH

1. This type of stitching is the one used most frequently.
2. The zig-zag presser foot can be used for both straight and zig-zag sewing.
3. For sewing light fabric, use smaller stitch size. (Refer to page 15 for dial setting).

ZIGZAG SEWING



zigzag width position

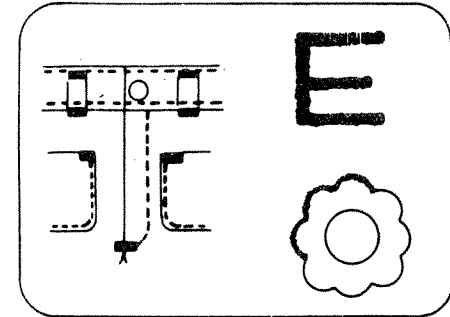

Satin stitching can be used for sewing initials, patterns, applique, etc.

BUTTON SEWING

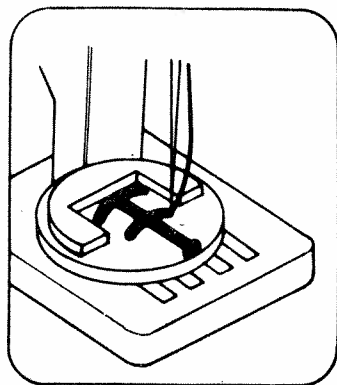
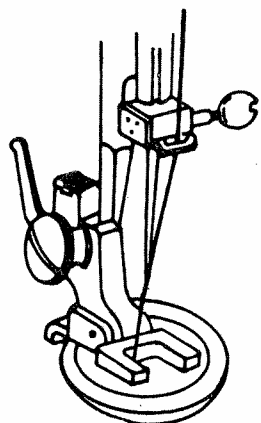

1. Lower drop feed.
2. Place button attaching presser foot in position.
3. Place button between presser foot and fabric and lower presser foot.
4. Manually turn hand wheel towards you ensuring that the needle enters into both holes of button without obstruction.
(Increase or decrease width setting).
5. Sew about 7 stitches.
6. Pull both threads to the underside and tie together.

ZIPPER SEWING

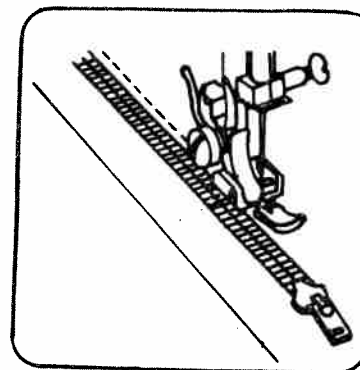

Select straight stitch.

1. Zipper foot is designed to sew close to a raised edge preventing sewing on zipper
2. Place zipper foot in position and attach firmly
3. Fold the fabric about 2 cm and place fabric under foot

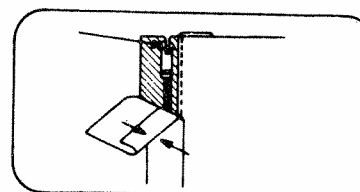

1. To sew the left side of zipper set the zipper foot on the right side of the needle.
2. To sew the right side of zipper set the zipper foot on the left side of the needle.

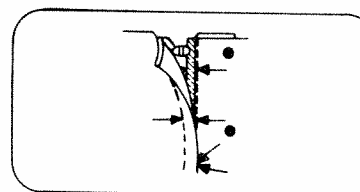

sew as illustrated.

HEMMING Note: Hemmer foot can be purchased separately.

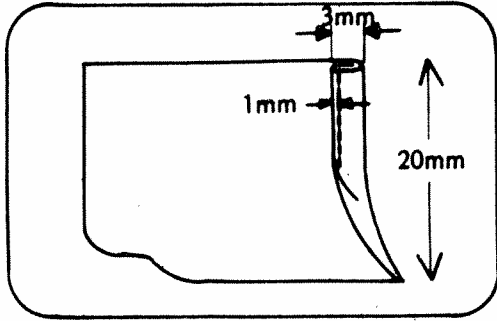

1. Raise the foot and the needle to its highest position. Replace the foot with the hemmer foot.
2. Fold over the fabric edge by about 3mm and place it under the foot. Secure the folded edge with a few stitches. Take out the workpiece and draw the hem into the hemmer foot by pulling the threads.

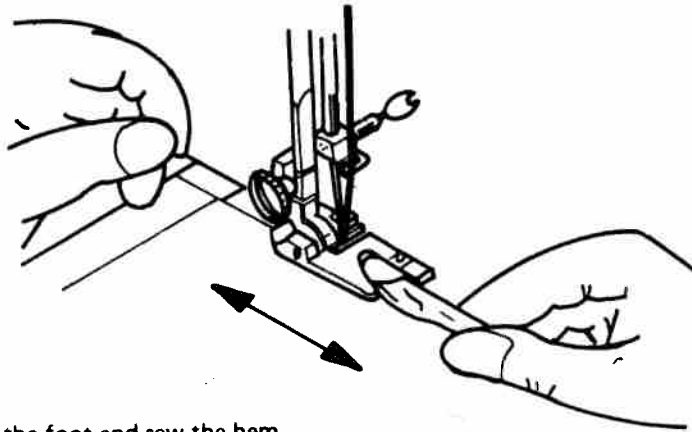

3. Lower the foot and sew the hem.
4. During sewing, fold the fabric to the left a little and allow it to run into the hemmer foot.
5. Make sure that the fabric does not move under the right half of the foot. The fabric must be fed in to the scroll of the hemmer sufficiently so that the workpiece edge runs freely through the groove under the foot.

Only suitable materials can be used and some practice may be necessary to achieve best results.

TWIN NEEDLE Note: Twin needle can be purchased separately

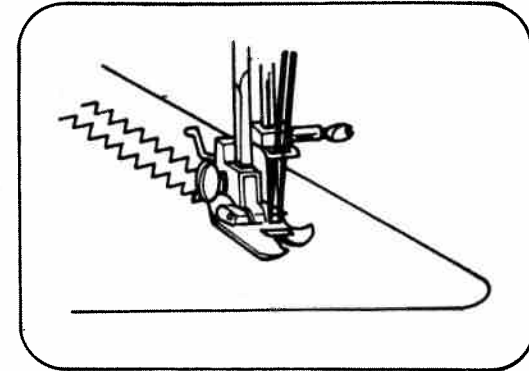

Remove regular needle and insert twin needle. Thread both threads through the same path as for normal sewing. Separate threads before last thread guide above the needle. Insert one thread into the right needle of twin needle. Insert other thread into the left needle of twin needle.

CAUTION: Do not set stitch width wider than number 2 setting. Exceeding this will cause breaking of needle.

EMBROIDERY

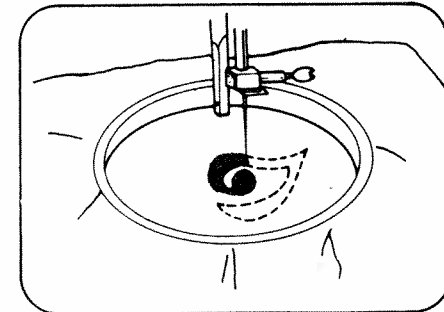

Lower feed dog and move hooped fabric slowly to form the desired effect. See Page 13 drop feed.

QUILTER

Note: Quilt guide can be purchased separately.

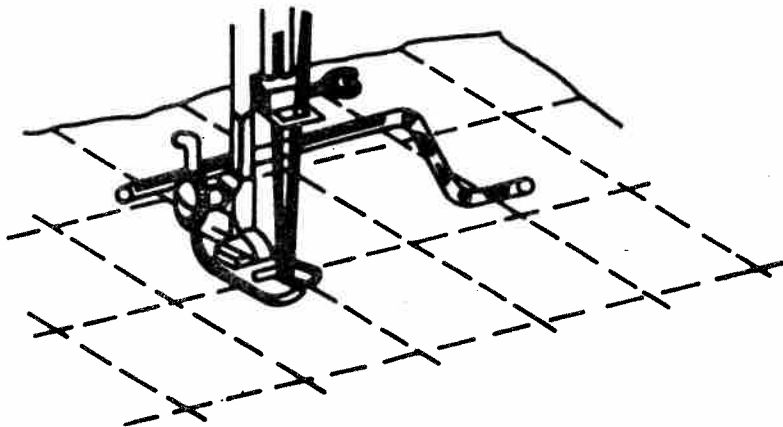

1. Slide arm through hole on top of presser foot holder.
2. Move guide to required stitch distance.

SEAM GUIDE

Note: Seam guide can be purchased separately.

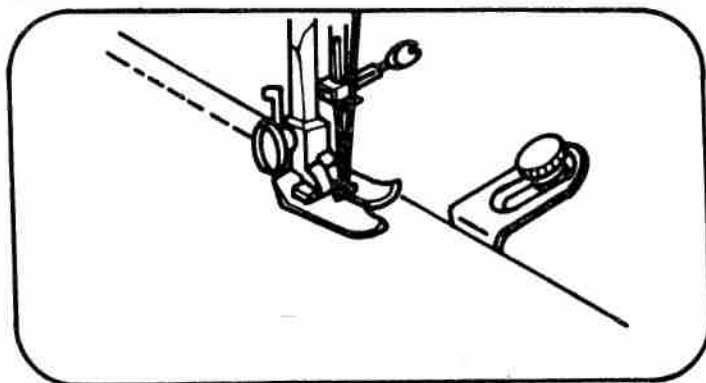

1. Use seam guide when sewing a long seam of regular distance from edge of material.
2. Set guide hole on bed, at right of needle plate, and adjust distance from the needle to the guide for desired seam allowance.
3. Run machine with edge of material touching guide.

BUTTONHOLE SEWING

1. MARK WITH A PENCIL OR CHALK THE EXACT LENGTH OF THE BUTTONHOLE ON THE FABRIC.
2. REMOVE THE REGULAR PRESSER FOOT AND ATTACH THE BUTTONHOLE FOOT & PUT THE FAB UNDER THE BUTTONHOLE FOOT.
3. SET THE STITCH LENGTH KNOB ON '0', ZIGZAG WIDTH KNOB ON '5' AND NEEDLE POSITION KNOB CENTER POSITION, THEN SEW 3-5 STITCHES AS FIGURE (1).
4. SET STITCH LENGTH ABOUT 0.5, ZIGZAG WIDTH KNOB ABOUT '2' NEEDLE POSITION KNOB ON L POSITION, THEN SEW AS FIGURE (2) UNTILL YOU REACHES THE END OF THE MARKING.
5. SET ZIGZAG WIDTH KNOB ON '5' THEN SEW 3-5 STITCHES AS FIGURE (3).
6. SET THE STITCH LENGTH KNOB ABOUT 0.5, ZIGZAG WIDTH KNOB ON 2, NEEDLE POSITION KNOB RIGHT POSITION, PUSH THE "R" BUTTON SEW UNTILL YOU REACHES THE END OF THE MARKING FIGURE (4).
7. REMOVE FABRIC FROM THE MACHINE AND OPEN THE BUTTONHOLE WITH A BUTTONHOLE CUT OR SEAM CUTTER.

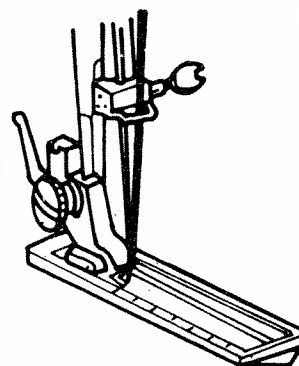
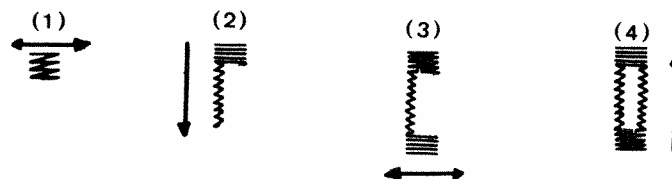

Before sewing fit buttonhole foot as shown.

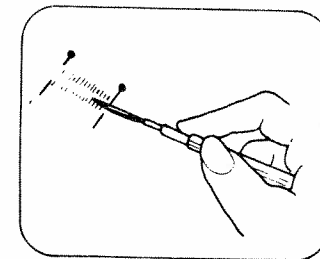

Cut buttonhole along centre with cutter as shown.

MAINTENANCE (CLEANING AND OILING)

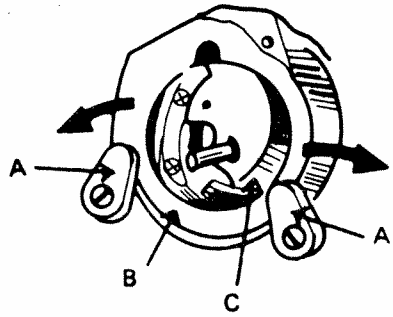

Cleaning shuttle race

- (A) Latch knob
- (B) Shuttle race cover
- (C) Shuttle hook

1. Raise needle to its highest position.
2. Take out bobbin case.
3. Turn latch knob A as illustrated.
4. Take off shuttle race cover.
5. Take out shuttle hook.
6. Clean and oil shuttle race and hook, then replace in the reverse order.

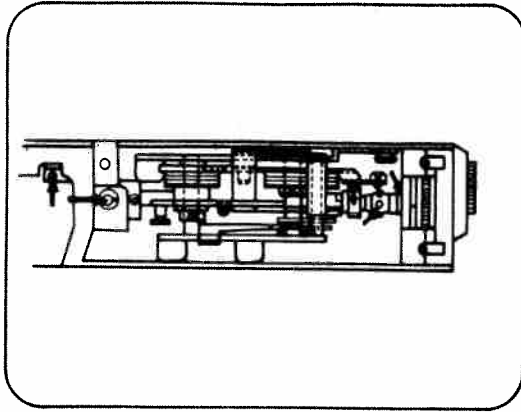

Open top cover and oil points indicated.

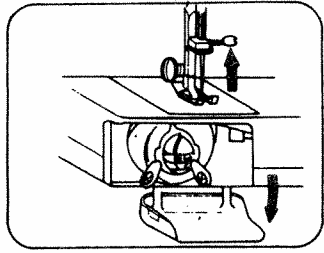

Open face cover and oil points indicated.

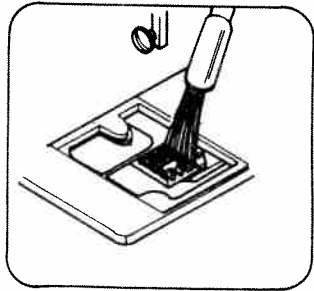

Cleaning feed dog

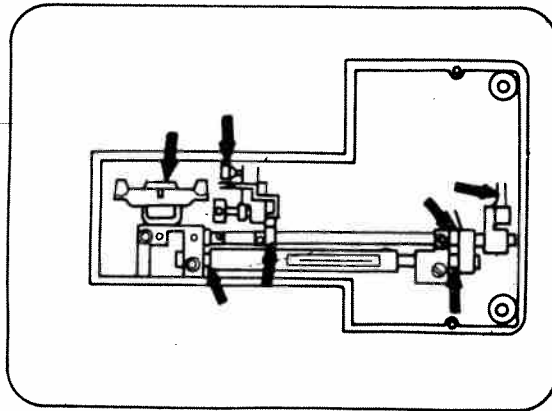

Oil points indicated on underside of bed base.

CHECKING PERFORMANCE PROBLEMS WHAT TO DO

PROBLEM	PROBABLE CAUSE	CORRECTION
Fabric not moving	<ul style="list-style-type: none"> - Feed dog down. - Machine not moving. - Stitch length dial in 0 position. - Light pressure on presser foot. 	<ul style="list-style-type: none"> - Raise feed dog. - Tighten stop motion. - Moving dial to 1-4. - Increase pressure on presser foot.
Breaking Needle	<ul style="list-style-type: none"> - Incorrect setting of needle. - Needle bent. - Pulling fabric. - Incorrect use of needle, thread or fabric. 	<ul style="list-style-type: none"> - Reset needle. - Fit new needle. - Do not pull fabric. - Correct use of needle, thread or fabric.
Breaking Bobbin Thread	<ul style="list-style-type: none"> - Improper threading. - Tight upper thread tension. - Needle bent. - Nicks or burrs on shuttle. 	<ul style="list-style-type: none"> - Re-thread machine. - Loosen upper thread tension. - Fit new needle. - Replace shuttle, or polish off burrs completely.
Machine Jamming Knocking Noise	<ul style="list-style-type: none"> - No oil. - Dust and thread in shuttle. 	<ul style="list-style-type: none"> - Needs oiling. - Clean shuttle.
Puckering	<ul style="list-style-type: none"> - Tension too tight. - Sewing foot pressure too strong. - Incorrect use of fabric, and thread. 	<ul style="list-style-type: none"> - Reset. - Adjust sewing foot pressure. - Use correct fabric, needle and thread.